

Article number: 20163B48852SW

Description: E+G

Base plate clamp GN163-B48-85-2-SW

Measures

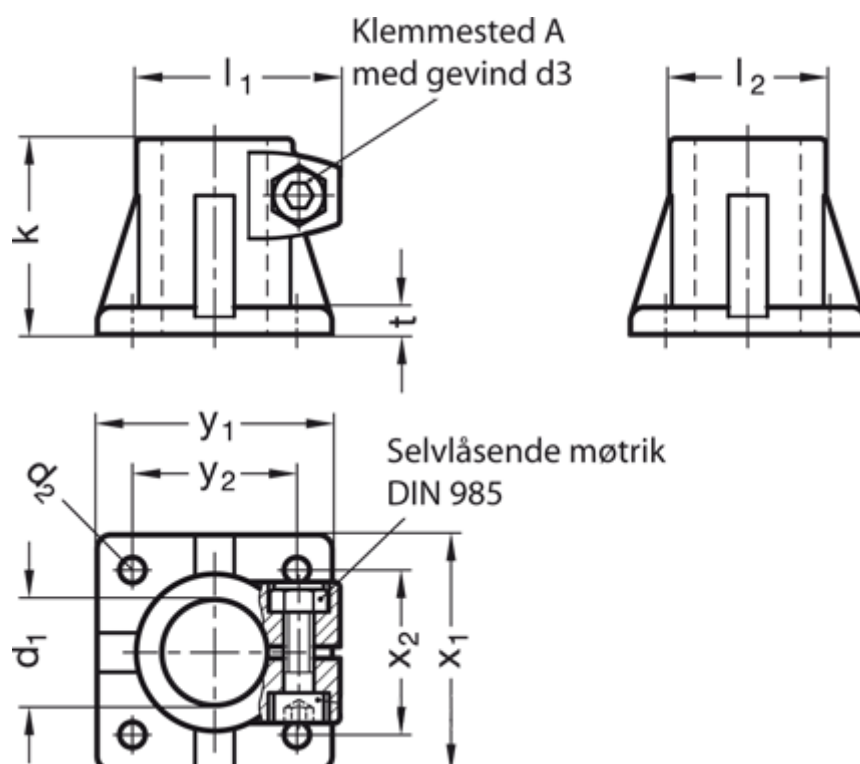

Adjustable clamp lever = GN 911-M10-50 have to be ordered separately

d1	= B48
d2	= 11.0
d3	= M10
k	= 85
l1	= 77.5
l2	= 65
t	= 14

x1 = 105
x2 = 74
y1 = 105
y2 = 74